

RASENTRAKTOREN
LAWN TRACTORS
Tracteurs de pelouse



GLORIA[®]
Geräte für Haus und Garten

Modelle 2007

Crossover

102 / 20 HE Hydro

Art. 65059

1

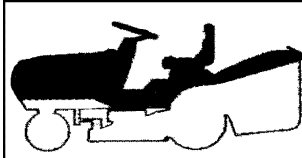

**KARROSSERIE
BODY
CARROSSERIE**

2

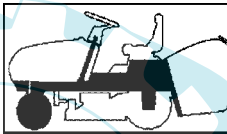

**RAHMENSATZ & LENKGETRIEBE
CHASSIS & STEERING
CHASSIS & BARRE DE DIRECTION**

3

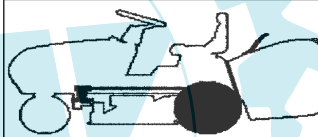

**GETRIEBE
TRANSMISSION
TRANSMISSION**

4



**MOTOR
ENGINE
MOTEUR**

5

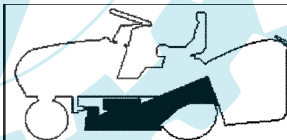

**SCHNEIDWERK
CUTTING PLATE
PLATEAU DE COUPE**

6

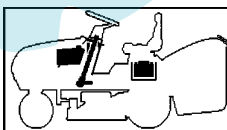

**TANK, BATTERIE & KOMPONENTEN
TANK, BATTERY & COMPONENTS
TANK, BATTERIE & COMPOSANTS**

7

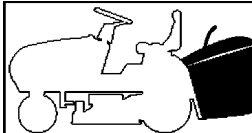

**GRASFANGSACK KPL.
GRASS CATCHER ASSY.
BAC COMPOSANTS**

8

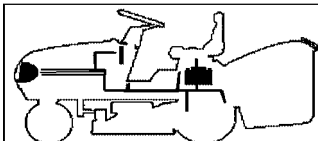

**ELEKTRIK 1
ELECTRIC 1
ELECTRIQUES 1**

9

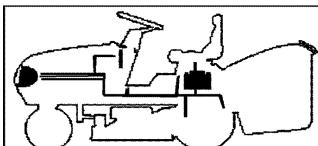

**ELEKTRIK 2
ELECTRIC 2
ELECTRIQUES 2**

1/24 RASENTRAKTOREN
2007 LAWN TRACTORS
Rev070903 Tracteurs de pelouse

Crossover

102 / 20 Hydro - Art. 65059
Modell 2007



Crossover
102 / 20 HE Hydro
Art. 65059
2007

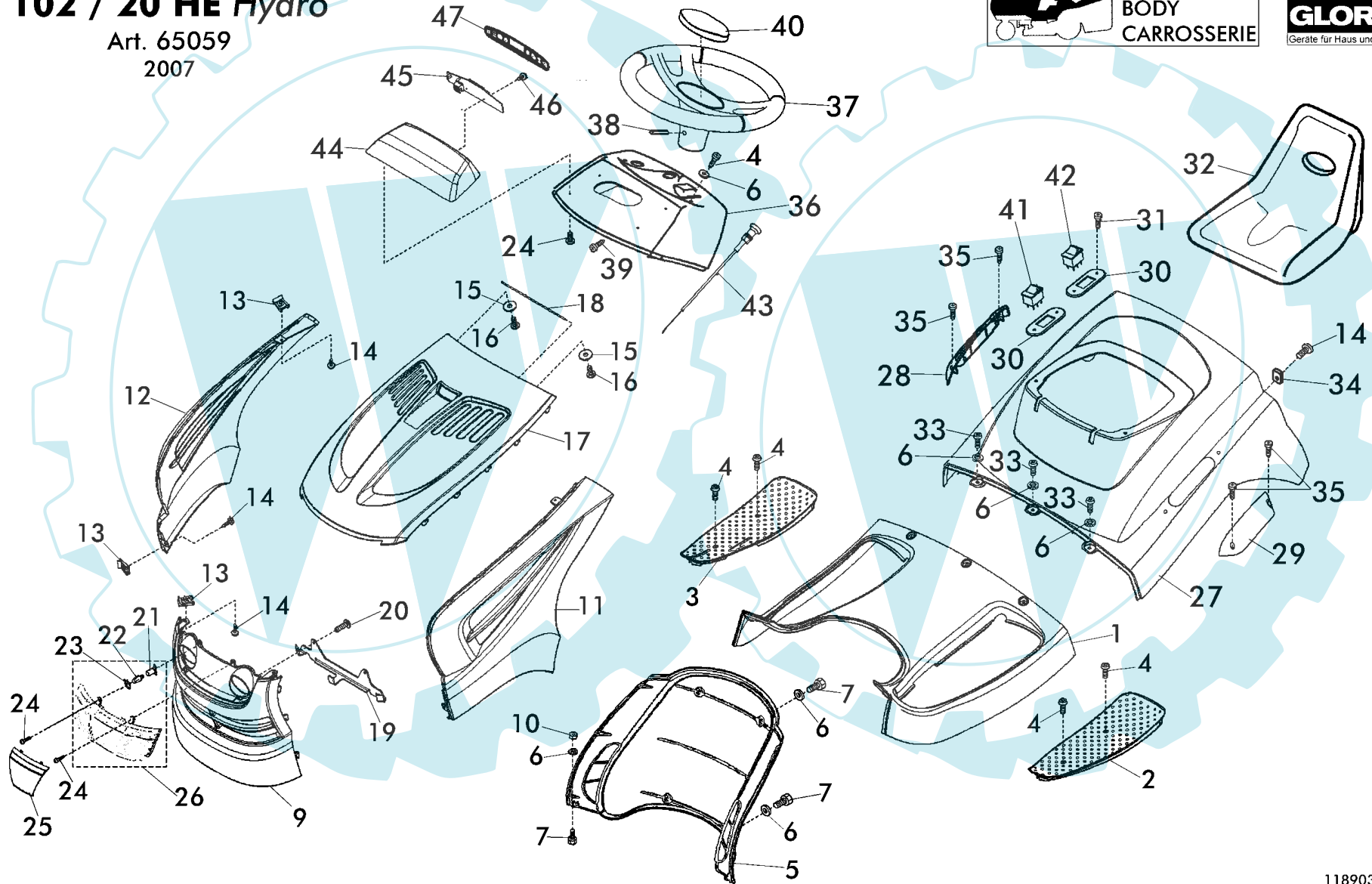

118903 z1-9

2/24		RASENTRAKTOREN		Crossover	
2007		LAWN TRACTORS		102 / 20 Hydro - Art. 65059	
Rev070903		Tracteurs de pelouse		Modell 2007	
Bild Nr. REF.N° POS.N°	BEST.-NR. PART-N° N° d. PIECE	BEZEICHNUNG	DESCRIPTION	DÉSIGNATION	Qty.
1	A46176247	ABDECKUNG, UNTEN	LOWER COVER PLATE	COUVRE	1
2	A51496401	TRITTPLATTE LINKS 102 R9005	LEFT FOOTBOARD	COUVRE MARCHEPIED GAU.	1
3	A46176301	TRITTPLATTE RECHTS R9005	RIGHT FOOTBOARD	COUVRE MARCHEPIED DROITE	1
4	A514316	SCHRAUBE SFS-TAPT 6X12 2019 A3R	SCREW	ECROU	6
5	A51400247	KONSOLE MOTORHAUBE R6001	CENTRAL DASHBOARD	SUPPORT TABLEAU CENTR.	1
6	A703005	SCHEIBE 6,4 9021-ST A3S	WASHER	RONDELLE	11
7	A704325	SCHRAUBE 6X 40 933- 8.8A3S	SCREW	ECROU	6
9	A52157347	FRONTTEIL HAUBE ALKO R6001	FRONT HOOD GREEN	CAPOT VERT	1
10	A704536	MUTTER 6KT 6 985- 8 A3B	NUT	ECROU	2
11	A52157647	SEITENTEIL LINKS HAUBE R6001	SIDE HOOD LEFT	CAPOT GAUCHE	1
12	A52157547	SEITENTEIL RECHTS HAUBE R6001	SIDE HOOD RIGHT	CAPOT DROITE	1
13	A521676	SCHNAPPMUTTER NU 0921	NUT NU 0921	ECROU NU 0921	6
14	A704752	SCHRAUBE KO 4,8X16 ZZ-C7981VZ	SCREW	ECROU	13
15	A700148	SCHEIBE 6,4 9021-ST VZ	WASHER	RONDELLE	2
16	A510177	SCHR AUBE PT-KB 60 X14 1411	SCREW	ECROU	2
17	A46273176	OBERTEIL HAUBE R7016	HOOD R7016	CAPOT R7016	1
18	A514419	FEDERSTAHL DRAHT VERZ	ROD	BARRE	1
19	A521460	SCHARNIERBLECH HAUBE	HOOD SUPPORT	CAPOT SUPPORT	1
20	A348947	SCHRAUBE PT-KB 60X20 1442	SCREW	ECROU	2
21	A514252	LAMPENFASSUNG TRAKTOR	LAMP HOLDER	DOUILLE DE LAMPE	2
22	A514251	LAMPE XENON 6W	FARILAMP XENON 6W	LAMPE XENON 6W	2
23	A521606	SCHLAUCHKLEMME "REFLEKTOR"	FAIR LED	FIXATION	2
24	A521679	SCHRAUBE PT-KB 30X12 WN 5452	SCREW	ECROU	6
25	A52157876	FRONTBLENDE	COVER PLATE	GRILL	1
26	A521554	SCHEINWERFER KPL HAUBE-4 XENON 6W	FLOOD LIGHT CARTRIDGE ASSY.	PHARE GARNITURE CPL.	1
27	A5140054710	MITTELKONSOLE HINTEN R6001 NACHARBEI	REAR COVER	COUVRE	1
28	A51414801	ABDECKUNG HÖHENVERSTELLUNG R9005	BEZEL R9005	BANDEAU R9005	1
29	A46177401	ABDECKUNG SCHALTKULISSE FUSSC R9005	BEZEL	BANDEAU	1
30	A521724	ABDECKUNG FÜR SCHALTER E-BOX	PLATE	PLAQUE	2
31	A518482	SCHRAUBE PT-KB50X18 1411	SCREW	ECROU	4
32	A514166	SITZ 1	SEAT	SIÈGE	1
33	A514317	SCHRAUBE SFS.TAPT6X16 2019 A3R	SCREW	ECROU	3



KARROSSERIE
BODY
CARROSSERIE

BRILL

GLORIA
Garten für Haus und Garten

3/24		RASENTRAKTOREN		Crossover	
2007		LAWN TRACTORS		102 / 20 Hydro - Art. 65059	
Rev070903		Tracteurs de pelouse		Modell 2007	
Bild Nr. REF.N° POS.N°	BEST.-NR. PART-N° N° d. PIECE	BEZEICHNUNG	DESCRIPTION	DÉSIGNATION	Qty.
34	A514331	BLECHMUTTER 4.8 FORM 1 VZ	NUT	ECROU	7
35	A514544	SCHRAUBE PT-KB60X30 1411A3R	SCREW	ECROU	2
36	A521474	BEDIENKONSOLE (DISPLAY+CHOKER)	DASHBOARD	TABLEAU DE BORD	1
37	A461117	LENKRAD KPL	STEERING WHEEL	VOLANT	1
38	A700664	SPANNHUELSE 8 X 60 1481	COLLET	DOUILLE	1
39	A518482	SCHRAUBE PT-KB50X18 1411	SCREW	ECROU	2
40	A46111801	ABDECKKAPPE FÜR LENKRAD R9005	STEERING CAP	BOUCHON	1
41	A521723	WIPPSCHALTER FÜR E-BOX	SWITCH	INTERRUPTEUR	1
42	A514879	SCHALTER JXA2Z00B-AZC00-000-XA	SWITCH	BOUTON	1
43	A521602	CHOKERZUG"CAPRO"	CHOKECONTROL	COMMANDE STARTER	1
44	A521477	ABDECKUNG	COVER DISPLAY	COUVERCLE	1
45	A521479	PLATINE"ELEKTROANZEIGE"	CIRCUIT BOARD	PLATINE	1
46	A704751	SCHRAUBE 3X 6 965-4.8-H-VZ	SCREW	ECROU	2
47	A521478	TASTATURFOLIE "ELEKTRIK+DISPLAY"	SCREEN	FILM DE PROTECTION	1

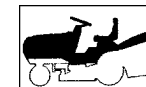

KARROSSERIE
BODY
CARROSSERIE

BRILL

GLORIA
Garden for Home and Garden

4/24 RASENTRAKTOREN

2007 LAWN TRACTORS

Rev070903 Tracteurs de pelouse

Crossover

102 / 20 Hydro - Art. 65059

Modell 2007

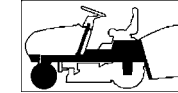

RAHMENSATZ & LENKGETRIEBE
CHASSIS & STEERING
CHASSIS & BARRE DE DIRECTION



Crossover 102 / 20 HE Hydro

Art. 65059
2007



RAHMENSATZ & LENKGETRIEBE
CHASSIS & STEERING
CHASSIS & BARRE DE DIRECTION



Geräte für Haus und Garten

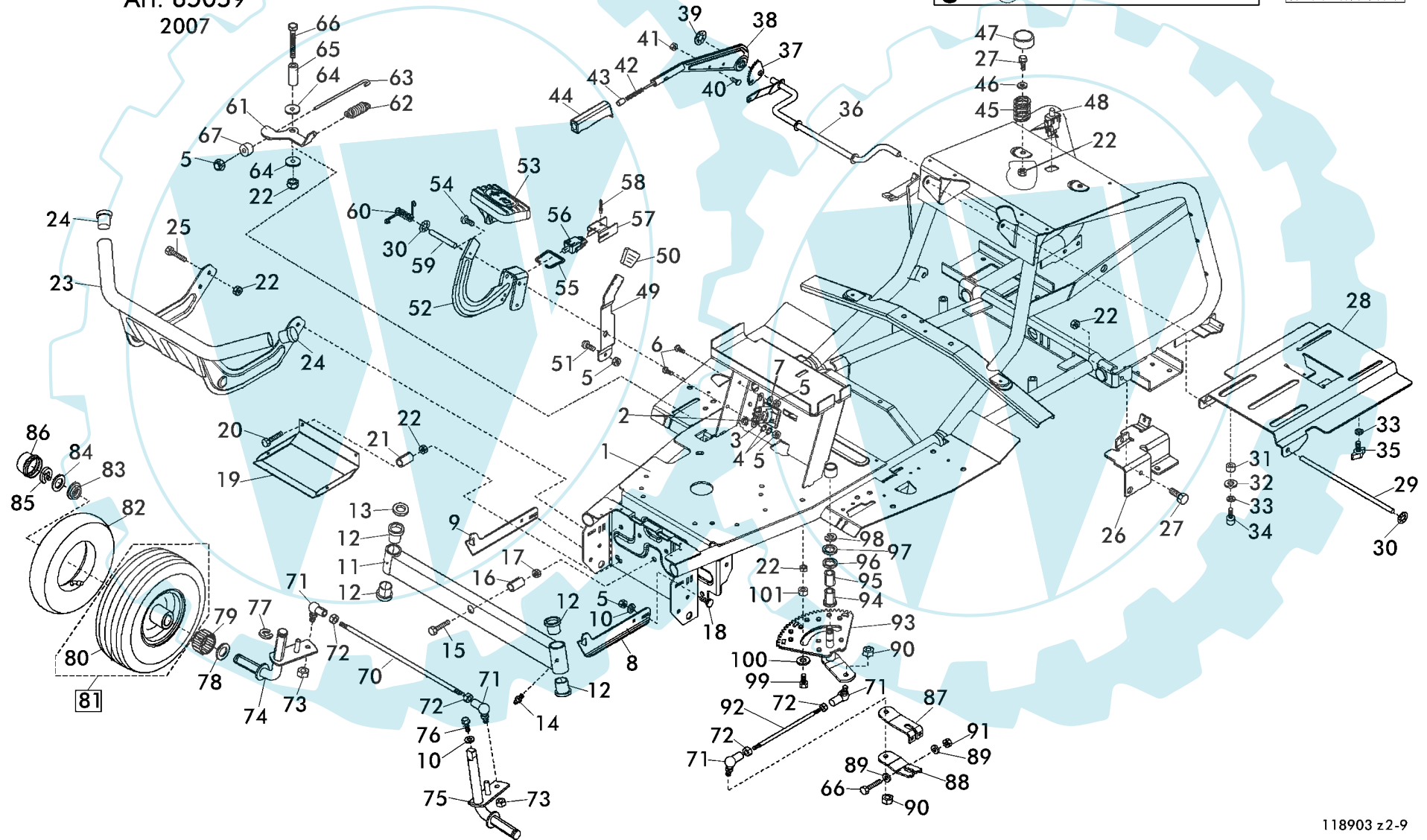

118903 z2-9

5/24		RASENTRAKTOREN		Crossover	
2007		LAWN TRACTORS		102 / 20 Hydro - Art. 65059	
Rev070903		Tracteurs de pelouse		Modell 2007	
Bild Nr. REF.N° POS.N°	BEST.-NR. PART-N° N° d. PIECE	BEZEICHNUNG	DESCRIPTION	DÉSIGNATION	Qty.
1	A52162501	RAHMEN GESCHW 102 E-BOX R9005	CHASSIS	CHASSIS	1
2	A521375	SKT-MUTTER+SPERRZ.1/4"-20 UN 8.8	NUT	ECROU	2
3	A521361	STARTERRELAIS 12V/100AMPER	STARTER RELAY	RELAIS D'ALL.	1
4	A700200	FÄCHERSCHEIBE - J 6,4 6798 VZ	SERRATED WASHER	RONDELLE	2
5	A704536	MUTTER 6 985- 8 A3B	NUT	ECROU	8
6	A704368	SCHRAUBE 6X 18 933- 8.8A3C	SCREW	ECROU	2
7	A703005	SCHEIBE 6,4 9021-ST A3S	WASHER	RONDELLE	1
8	A521462	ANBINDUNGSBLECH LINKS	BRACKET LEFT	RENFORCEMENT GAUCHE	1
9	A521461	ANBINDUNGSBLECH RECHTS	BRACKET RIGHT	RENFORCEMENT DROITE	1
10	A700148	SCHEIBE 6,4 9021-ST VZ	WASHER	RONDELLE	5
11	A46177701	VORDERACHSE 15" GESCHW R9005	FRONT AXLE 15"	AXE AVANT	1
12	A514042	BUCHSE-ACHSSCHENKEL	BRASS	COUSSINET	4
13	A700719	SCHEIBE 21 433 VZ	WASHER	RONDELLE	1
14	A700203	NIPPEL AS 6X1 KEG 71412	GREASE DISPENSER	GRAISSEUR	2
15	A702812	SCHRAUBE 10X 55 931- 8.8A3C	SCREW	ECROU	1
16	A51436030	LAGERBUCHSE-VORDERACHSE VERZ	SPACER	ENTRETOISE	1
17	A703813	SKT-MUTTER 985-10 A3B	NUT	ECROU	1
18	A704138	SCHRAUBE 6X 16 603- 4.6A3B	SCREW	ECROU	4
19	A521475	WÄRMELEITBLECH UNTEN H-4 UND 2 ZYLIND	LOWER HEAT GUARD	PROTECTION	1
20	A701011	SCHRAUBE 8X 50 933- 8.8VZ	SCREW	ECROU	4
21	A514299	PENDELANSCHLAG VERZ	BLOCK	BLOC	4
22	A704537	SKT-MUTTER 8 985- 8 A3B	NUT	ECROU	13
23	A46189340	STOSSTANGE 30 MM LANG R9006 BRILL	BUMPER R9006	PARE-CHOCS	1
24	A519076	ROHRSTOPFEN FÜR ROHR 30X2	COVER	BOUCHER	2
25	A700545	SCHRAUBE 8X 16 933- 8.8VZ	SCREW 8X 16 933- 8.8VZ	VIS 8X 16 933- 8.8VZ	4
26	A461761	BREMSZUGWIDERLAGER	BRACKET	EQUERRE-SUPPORT	1
27	A704546	SCHRAUBE 8X 20 933- 8.8A3B	SCREW 8X 20 933- 8.8A3B	VIS 8X 20 933- 8.8A3B	3
28	A521395	VERSTELLKONSOLE SITZ GENIETET	PLATE	PLAQUE	1
29	A51414130	LAGERSTANGE SITZKONSOLE VERZ	ROD	BARRE	1
30	A510566	SCHNELLBEFESTIGER 8SXN26	CROWN FASTENER	FIXATEUR A COURONNE	3
31	A521727	DISTANZBUCHSE	SPACER	ENTRETOISE	2
32	A700150	SCHEIBE 8,4 9021-ST VZ	WASHER 8,4 9021-ST VZ	RONDELLE 8,4 9021-ST VZ	2
33	A701765	SCHEIBE FÄCHER- A 8,4 6798 VZ	WASHER FÄCHER- A 8,4 6798 VZ	RONDELLE FÄCHER- A 8,4 6798 VZ	4
34	A700051	SCHRAUBE 8X 20 912- 8.8 VZ	SCREW 8X 20 912- 8.8 VZ	VIS 8X 20 912- 8.8 VZ	2
35	A521480	FLÜGELSCHRAUBE M8X20	SCREW	VIS	2

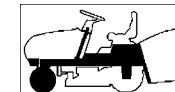

RAHMENSATZ & LENKGETRIEBE
CHASSIS & STEERING
CHASSIS & BARRE DE DIRECTION

BRILL

GLORIA
Garten für Haus und Garten

6/24		Crossover		102 / 20 Hydro - Art. 65059	
2007		LAWN TRACTORS		Modell 2007	
Rev070903		Tracteurs de pelouse		 RAHMENSATZ & LENKGETRIEBE CHASSIS & STEERING CHASSIS & BARRE DE DIRECTION	
Bild Nr. REF.N° POS.N°	BEST.-NR. PART-N° N° d. PIECE	BEZEICHNUNG	DESCRIPTION	DÉSIGNATION	Qty.
36	A51484530	LAGERWELLE GESCHW VERZ	SHAFT	ARBRE	1
37	A625877	SEGMENT "FE/ZN 12 F"	STEERING SHAFT	ARBRE DIRECTION	1
38	A514224	HEBEL KPL.HÖHENVERSTELLUNG	LEVER	LEVIER	1
39	A513010	SCHNELLBEFESTIGER16 SXN27	CROWN FASTENER	FIXATEUR A COURONNE	1
40	A703974	SCHRAUBE 5X 20 965-4.8-H A3B	SCREW	VIS	1
41	A701478	MUTTER HUT 5 986- 8 VZ	NUT	ECROU	1
42	A2045480006	FEDER F. HANDGRIFF T	SPRING	RESSORT	1
43	A2042850001	DRUCKKNOPF F. BR-HEBEL T	BUTTON	POUSSOIR	1
44	A375725	HANDGRIFF HOENENVERST. T	KNOB	POIGNEE	1
45	A514307	DRUCKFEDER FÜR SITZ	SPRING	RESSORT	2
46	A700150	SCHEIBE 8,4 9021-ST VZ	WASHER	RONDELLE	2
47	A514346	ABDECKKAPPE D-35 RAL9005	HOOD	PROTECTEUR	2
48	A514327	DRUCKSCHALTER	PRESS SWITCH	INTERRUPTEUR À PRESSION	1
49	A514410	FESTSTELLFEDER RECHTS	SPRING	RESSORT	1
50	A302231	KAPPE R9005	CAP	BONNET	1
51	A700555	SCHRAUBE 6X 16 933- 8.8VZ	SCREW	VIS	1
52	A51406830	PEDAL RECHTS VERZ	DRIVE PEDAL	PEDALE TRANSMISSION	1
53	A46176401	PEDALAUFLAGE BREMSE UND KUPPL. R9005	CLAMP COVER FRONT	COUVRE ETRIER AVANT	1
54	A514316	SCHRAUBE SFS-TAPT 6X12 2019 A3R	SCREW	VIS	1
55	A514396	BÜGEL	CONNECTING PLATE	PAQUE DE CONNEXION	1
56	A514327	DRUCKSCHALTER	PRESS SWITCH	INTERRUPTEUR À PRESSION	1
57	A514385	SCHALTERHALTER	SUPPORT	SUPPORT	1
58	A701395	BLINDNIET 4,0X 8	RIVET	RIVET	2
59	A51442430	LAGERBOLZEN PEDAL VERZ.	PIN	PIVOT	1
60	A514386	DREHFEDER RECHTS	SPRING	RESSORT	1
61	A461497	WIPPE FÜR KUPPLUNG FAHRANTRIEB	ROCKER	BASCULE	1
62	A461500	ZUGFEDER FÜR KUPPLUNG FAHRANTRIEB	SPRING	RESSORT	1
63	A461498	ZUGSTANGE FÜR KUPPLUNG FAHRANTRIEB	LINKAGE	BARRE DE TRACTION	1
64	A461501	LAGERSCHEIBE FÜR KUPPLUNG FAHRANTRIEB	DISK	DISQUE	2
65	A461499	ROHR FÜR KUPPLUNG FAHRANTRIEB VERZ	TUBE	TUYAU	1
66	A701985	SCHRAUBE 8X 55 931- 8.8VZ	SCREW	VIS	2
67	A461502	KUGELFÜHRUNG FÜR KUPPLUNG FAHRANTRIEB	GUIDANCE	GUIDAGE	1
70	A461784	SPURSTANGE 15"	TIE ROD	TIRANT	1
71	A514701	WINKELGELENK CS16-M10+SIC	JOINT	JOINT	4
72	A704534	MUTTER 10 934- 8 A3B	NUT	ECROU	4

7/24		RASENTRAKTOREN		Crossover	
2007		LAWN TRACTORS		102 / 20 Hydro - Art. 65059	
Rev070903		Tracteurs de pelouse		Modell 2007	
Bild Nr. REF.N° POS.N°	BEST.-NR. PART-N° N° d. PIECE	BEZEICHNUNG	DESCRIPTION	DÉSIGNATION	Qty.
73	A703813	MUTTER 6KT 10 985-10 A3B	NUT	ECROU	2
74	A46178330	ACHSSCHENKEL RECHTS 15" GESCHW VERZ	RIGHT STUB AXLE	FUSEAU DROITE	1
75	A46178230	ACHSSCHENKEL LINKS 15" GESCHW VERZ	LEFT STUB AXLE	FUSEAU GAUCHE	1
76	A523134	SFS-TAPT.M6X12 2021 A2K	SCREW	VIS	1
77	A702724	SCHEIBE SICH 15 6799 VZ	WASHER	RONDELLE	1
78	A701166	SCHEIBE PA 20X28X0,5 988	WASHER	RONDELLE	2
79	A521268	ROLLENLAGER 20X30X55	ROLLER BEARING	COUSSINET	2
80	A461865	REIFEN 15X6,00-6 2PR	SHOE	PNEU	2
81	A46174140	VORDER-RAD 15X6.00-6 BREIT KPL R9006	FRONT WHEEL	ROUE AVANT	2
82	A461866	SCHLAUCH 15X6,00-6 TR13	HOSE	TUYAU	2
83	A450263	BUCHSE TRAKTOR VORDERRAD	BUSH	DOUILLE	2
84	A461290	SCHEIBE 42MM FÜR TRAKTOR	WASHER	RONDELLE	2
85	A702724	SCHEIBE SICH 15 6799 VZ	WASHER	RONDELLE	2
86	A461289	ABDECKKAPPE"TRAKTOR"	HUB COVER	COUVRE MOYEU	2
87	A46110830	LENKHEBEL 2 TEILIG OBEN VERZ	UPPER STEERING ARM	LEVIER GUIDER EN HAUT	1
88	A46110730	LENKHEBEL 2 TEILIG UNTEN VERZ	LOWER STEERING ARM	LEVIER GUIDER EN BAS	1
89	A701083	SCHEIBE 8,4VZ7349"701083"	WASHER	RONDELLE	2
90	A461231	MUTTER SICH- BIW M10 A3B- 8	NUT	ECROU	2
91	A348988	MUTTER SICH- BIW M 8 A3C- 8 MITTELGESIC	NUT	ECROU	1
92	A46111130	SCHUBSTANGE VERZ	STEERING ROD DIRECTION	LEVIER BARRE DE	1
93	A46110530	LENKSEGMENT GESCHW VERZ	SEGMENT	SEGMENT GUIDER	1
94	A461109	BUNDBUCHSE LENKUNG	COLLAR BUSH	DOUILLE	1
95	A461110	BUCHSE	BUSH	DOILLE	1
96	A704540	SCHEIBE A 13 125-ST A3B	WASHER	RONDELLE	1
97	A702574	SCHEIBE PA 14X20X1,0 988 VZ	WASHER	RONDELLE	1
98	A702893	SCHEIBE SICH 10 6799 DAC	WASHER	RONDELLE	1
99	A702381	SCHRAUBE 8X 30 7991- 8.8 VZ	SCREW	VIS	1
100	A521123	SCHEIBE D50X5	WASHER	RONDELLE	1
101	A51438730	DISTANZBUCHSE VERZ	SPACER	BAGUE D'ÉCARTEMENT	1

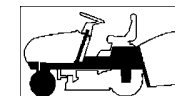

RAHMENSATZ & LENKGETRIEBE
CHASSIS & STEERING
CHASSIS & BARRE DE DIRECTION

BRILL

GLORIA
Garten für Haus und Garten

8/24 RASENTRAKTOREN

2007 LAWN TRACTORS

Rev070903 Tracteurs de pelouse

Crossover

102 / 20 Hydro - Art. 65059

Modell 2007



BRILL

GLORIA

Geräte für Haus und Garten

Crossover

102 / 20 HE Hydro

Art. 65059

2007



BRILL

GLORIA

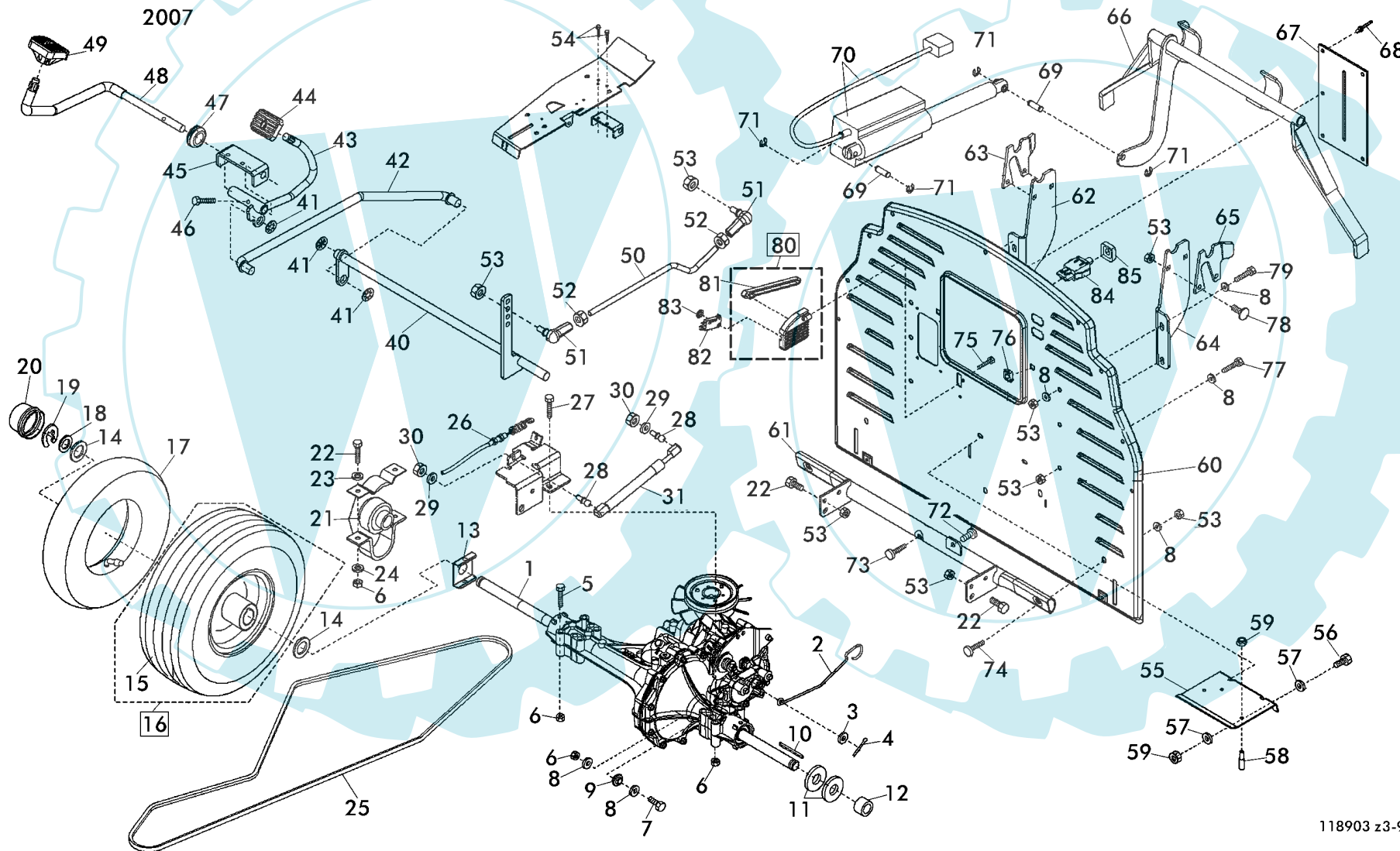

Geräte für Haus und Garten



118903 z3-9

9/24	RASENTRAKTOREN	Crossover		GETRIEBE TRANSMISSION TRANSMISSION	
2007	LAWN TRACTORS	102 / 20 Hydro - Art. 65059		BRILL	
Rev070903	Tracteurs de pelouse	Modell 2007		GLORIA Garten für Haus und Garten	
Bild Nr. REF.N° POS.N°	BEST.-NR. PART-N° N° d. PIECE	BEZEICHNUNG	DESCRIPTION	DÉSIGNATION	Qty.
1	A461773	GETRIEBE-HYDRO GEAR FUSSC"358-0510"	HYDRO TRANSMISSION ASSY	TRANSMISSION AUTOMATIQUE HYDRO	1
2	A461772	BAYPASSHEBEL HYDRO FUSSCONTROL	LEVER	LEVIER	1
3	A700148	SCHEIBE 6,4 9021-ST VZ	WASHER	RONDELLE	1
4	A705322	SPL 2 X 20 94 A3B	SPLINT	AUBIER	1
5	A704744	SCHRAUBE 8X 65 931- 8.8A3B	SCREW	VIS	2
6	A704537	MUTTER 6KT 8 985- 8 A3B	NUT	ECROU	6
7	A704545	SCHRAUBE 8X 25 933- 8.8A3B	SCREW	VIS	1
8	A700150	SCHEIBE 8,4 9021-ST VZ	WASHER	RONDELLE	15
9	A461771	BUCHSE FÜR BREMSHEBEL VERZ	BUSH	DOILLE	1
10	A514313	PASSFEDER 3/16"X3/16"X2 1/4	FIT-IN KEY	GOUPILLE	2
11	A461473	ANLAUFSCHIEBE 52119	WASHER	RONDELLE	2
12	A461494	DISTANZHÜSLE LINKES RAD HY-GEAR 310-05	SPACER	DOUILLE	1
13	A461429	KLEMMBLECH 51118	CLAMP PLATE	BORNE	1
14	A704263	SCHEIBE S 19X26X1,5 988A3C	WASHER	RONDELLE	4
15	A461536	MANTEL FÜR REIFEN 18X8,50-8 2PR	SHOE	PNEU	2
16	A52185340	HINTER-RAD 18X8.5-8 BREIT KPL R9006	REAR WHEEL CPL	ROUE ARRIERE CPL	2
17	A546222	SCHLAUCH 18"X8.5"-8 / 9.50-8 TR13	HOSE	TUYAU	2
18	A461290	SCHEIBE 42MM FÜR TRAKTOR	WASHER	RONDELLE	2
19	A702724	SCHEIBE SICH 15 6799 VZ	WASHER	RONDELLE	2
20	A461289	ABDECKKAPPE"TRAKTOR"	HUB COVER	COUVRE MOYEU	2
21	A514081	Y-STEHLAGER 3/4"	SUPPORT ASSY	SUPPORT CPL	1
22	A704546	SCHRAUBE 8X 20 933- 8.8A3B	SCREW	VIS	6
23	A704272	SCHEIBE PA 8X14X1,0 988	WASHER	RONDELLE	2
24	A704538	SCHEIBE A 8,4 125-ST A3B	WASHER	RONDELLE	2
25	A514882	FAHRANTRIEBSRIEMEN 102 HD	BELT	COURROIE	1
26	A514157	SCHALT-BOWDENZUG-BREMSE	BOWDEN CABLE	FIL	1
27	A700303	SCHRAUBE 8X 70 931- 8.8VZ	SCREW	VIS	2
28	A461789	KUGELKOPF 51426	ADAPTER	ADAPTER	2
29	A700128	RG FED- B 8 127 VZ	LOCK WASHER	DISQUE DE RESSORT	2
30	A461431	MUTTER 5/16" UNC B	NUT	ECROU	2
31	A461788	DÄMPFER 52406	BUFFER	AMORTISSEUR	1
40	A46176030	UMLENKUNG HINTEN GESCHW VERZ	SHAFT ASSY	LEVIER CPL	1
41	A512725	SCHNELLBEFESTIGER 14SXN26	CROWN FASTENER	FIXATEUR A COURONNE	3
42	A46175630	VERBINDUNGSSTAB GESCHW VERZ	CONNECTION ROD	BARRE DE CONNEXION	1
43	A46175130	PEDAL RÜCKWÄRTS GESCHW VERZ			1

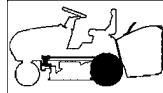
10/24		Crossover		GETRIEBE TRANSMISSION TRANSMISSION		BRILL Gloria für Haus und Garten	
2007		LAWN TRACTORS		102 / 20 Hydro - Art. 65059			
Rev070903		Tracteurs de pelouse		Modell 2007			
Bild Nr. REF.N° POS.N°	BEST.-NR. PART-N° N° d. PIECE	BEZEICHNUNG	DESCRIPTION	DÉSIGNATION	Qty.		
44	A46179101	PEDALAUFLAGE RÜCKWÄRTS HY-FUßS R9005	PEDAL BACKWARD	PEDAL EN ARRIÈRE	1		
45	A46174830	LAGERBOCK FÜR PEDAL VERZ	BEARING BRACKET	CHEVALET SUPPORT	1		
46	A510434	SCHRAUBE SFS-TAPT.6X20 2016	SCREW	VIS	1		
47	A461766	DURCHFÜHRUNGSTÜLLE	FIXING RING	ANNEAU DE GUIDAGE	1		
48	A461793	PEDAL VORWÄRTS MIT SS HY-FUSSC R9005	PEDAL FORWARD	PEDAL EN AVANCER	1		
49	A46179001	PEDALAUFLAGE VORWÄRTS HY-FUßS R9005	CLAMP COVER REAR	COUVRE ETRIER ARRIERE	1		
50	A461768	GEWINDESTAB	THREAD ROD	TIGE FILETÉE	1		
51	A514239	WINKELGELENK C13SXN68/02R	JOINT	JOINT	2		
52	A704533	MUTTER 8 934- 8 A3B	NUT	ECROU	2		
53	A704537	MUTTER 6KT 8 985- 8 A3B	NUT	ECROU	19		
54	A523134	SFS-TAPT.M6X12 2021 A2K	SCREW	VIS	2		
55	A461514	RIEMENFÜHRUNG HINTEN	BELT GUIDE	GUIDE DE COURROIRE	1		
56	A700555	SCHRAUBE 6X 16 933- 8.8VZ	SCREW	VIS	2		
57	A700137	SCHEIBE A 6,4 125-ST VZ	WASHER	RONDELLE	4		
58	A461506	BOLZEN	BOLT	BOULLON	2		
59	A704536	MUTTER 6KT 6 985- 8 A3B	NUT	ECROU	4		
60	A46151001	RÜCKWAND 102 E-BOX+DISPLAY R9005	REAR PANEL	PANNEAU ARRIÈRE	1		
61	A46177001	DREHMOMENTABSTÜTZUNG FUSSC GES R9005	REAR SHAFT ASSY	ARBRE ARRIÈRE	1		
62	A52162001	HALTEARM RECHTS GETEILT R9005	RIGHT SUPPORT	SUPPORT DROITE	1		
63	A52162101	HALTEARM RECHTS GETEILT OBEN R9005	RIGHT SUPPORT PLATE	PANNEAU SUPPORT DROITE	1		
64	A52162201	HALTEARM LINKS GETEILT R9005	LEFT SUPPORT	SUPPORT GAUCHE	1		
65	A52162301	HALTEARM LINKS GETEILT OBEN R9005	LEFT SUPPORT PLATE	PANNEAU SUPPORT GAUCHE	1		
66	A52160701	SCHWINGE FÜR ZYLINDER GESCHW R9005	BAIL	AILE	1		
67	A521960	DICHTUNG FÜR E-BOX	PLATE	PLATEAU	1		
68	A701395	BLINDNIET 4,0X 8	RIVET	RIVET	6		
69	A52172130	BOLZEN FÜR ZYLINDER VERZ	BOLT	BOULLON	2		
70	A521748	LINEARZYLINDER VORMONTIERT KPL	CYLINDER ASSY	VÉRIN CPL	1		
71	A702353	SCHEIBE SICH 7 6799 A3C	WASHER	RONDELLE	4		
72	A461808	SCHRAUBE SKT 5/16" X 16 SELBSTSCHNEID	SCREW	VIS	1		
73	A701521	SCHRAUBE 8X 40 933- 8.8VZ	SCREW	VIS	1		
74	A700967	SCHRAUBE 8X 35 603- 4.6VZ	SCREW	VIS	2		
75	A511693	SCHRAUBE PT-KB 5X10 WN1411 A3B	SCREW	VIS	2		
76	A321126	MUTTER KASTEN- M 6-ST GALVZ+PASSI	SQUARE NUT	ECROU	2		
77	A703892	SCHRAUBE 8X 45 933- 8.8A3B	SCREW	VIS	2		
78	A700844	SCHRAUBE 8X 20 603- 4.6VZ	SCREW	VIS	4		

11/24	RASENTRAKTOREN	Crossover			 GETRIEBE TRANSMISSION TRANSMISSION	  Geräte für Haus und Garten
2007	LAWN TRACTORS	102 / 20 Hydro - Art. 65059				
Rev070903	Tracteurs de pelouse	Modell 2007				
Bild Nr. REF.N° POS.N°	BEST.-NR. PART-N° N° d. PIECE	BEZEICHNUNG	DESCRIPTION	DÉSIGNATION	Qty.	
79	A701011	SCHRAUBE 8X 50 933- 8.8VZ	SCREW	VIS	4	
80	A521339	FÜLLSTANDSUMMERGEHÄUSE UND HEBEL	PROTECTION COVER & LEVER CPL	COUVERCLE PROTECTION & LEVIER CPL	1	
81	A514682	SCHALTHEBEL LANG	LEVER	LEVIER	1	
82	A514329	MIKROSCHALTER FÜLLSTANDANZEIGE	SWITCH	INTERRUPTEUR	1	
83	A526521	SCHNELLEBFESTIGER 3SXN26	CROWN FASTENER	FIXATEUR A COURONNE	2	
84	A514327	DRUCKSCHALTER	PRESS SWITCH	INTERRUPTEUR À PRESSION	2	
85	A514337	ABDECKTÜLE FÜR DRUCKSCHALTER	COVER	COUVERCLE PROTECTION	2	

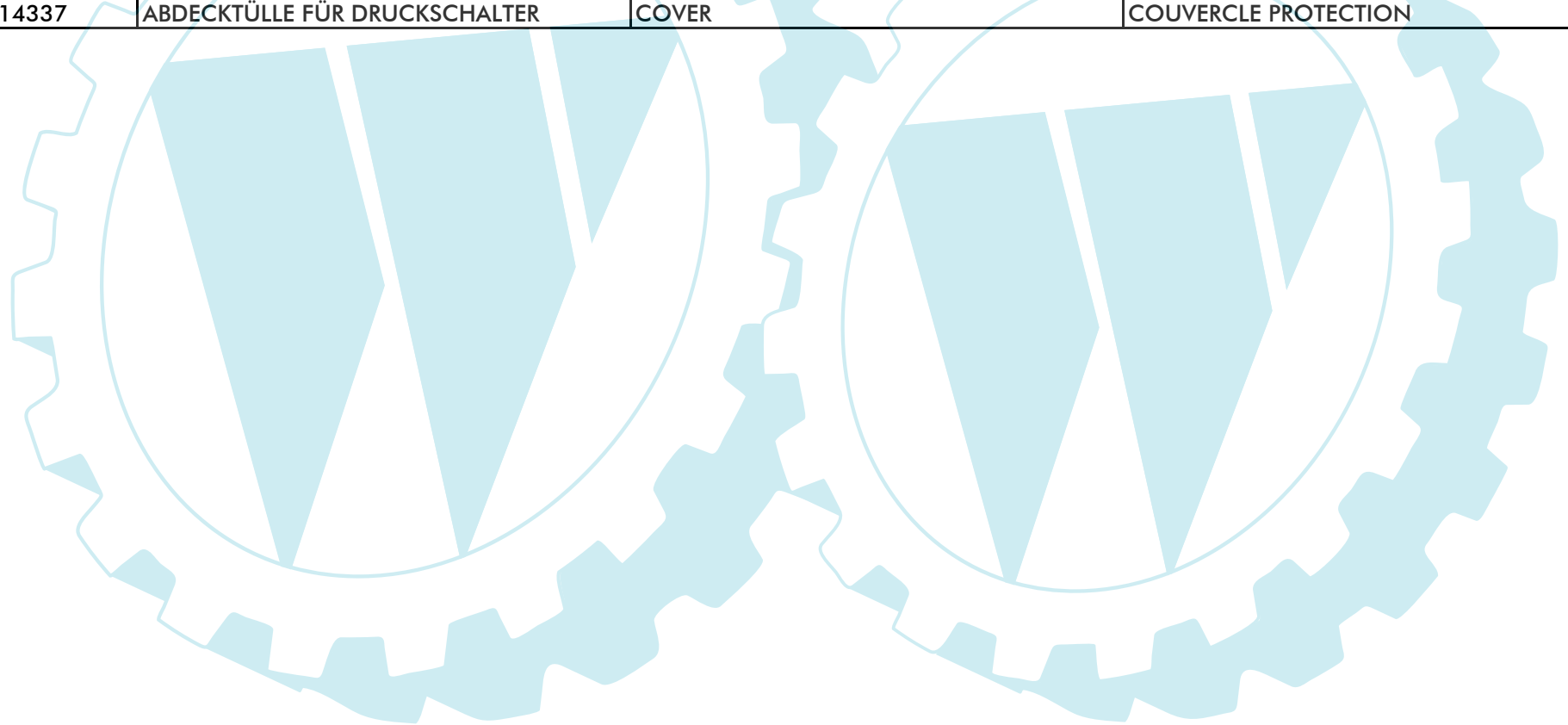

12/24 RASENTRAKTOREN
2007 LAWN TRACTORS
Rev070903 Tracteurs de pelouse

Crossover

102 / 20 Hydro - Art. 65059
Modell 2007



Crossover
102 / 20 HE Hydro
Art. 65059
2007

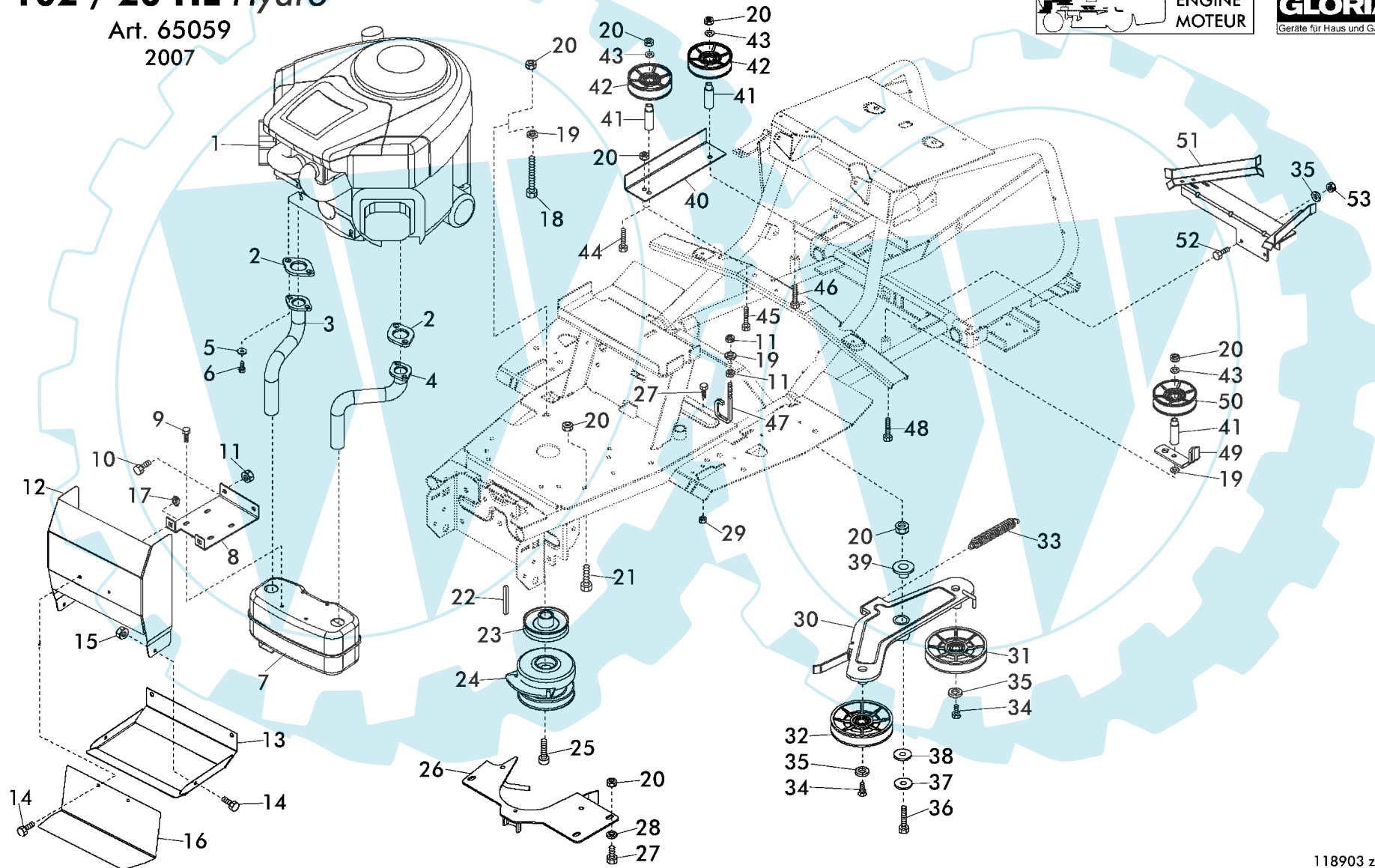

118903 z4-9

13/24		RASENTRAKTOREN		Crossover	
2007		LAWN TRACTORS		102 / 20 Hydro - Art. 65059	
Rev070903		Tracteurs de pelouse		Modell 2007	
Bild Nr. REF.N° POS.N°	BEST.-NR. PART-N° N° d. PIECE	BEZEICHNUNG	DESCRIPTION	DÉSIGNATION	Qty.
1	A521597	MOTOR B&S 20HP OHV INTEK	MOTOR 20HP OHV INTEK	MOTEUR 20HP OHV INTEK	1
2	A514618	DICHTUNG	SEAL	JOINT	2
3	A521583	KRÜMMER RECHTS 18/20/22/25 GESCHW	MUFFLER TUBE RIGHT	TUYAU D'ÉCHAPPEMENT DROITE	1
4	A521585	KRÜMMER LINKS 18/20/22/25 GESCHW	MUFFLER TUBE LEFT	TUYAU D'ÉCHAPPEMENT GAUCHE	1
5	A702756	SCHEIBE SICHTSCHNORR S 8 MECHANVZ	WASHER	RONDELLE	4
6	A461209	SCHRAUBE ISKT UNC 5/16"X 3/4"A3B	SCREW	VIS	4
7	A521683	AUSPUFF 2-ZYLINDER NELSON	MUFFLER	SILENCIEUX NELSON CPL	1
8	A521469	AUSPUFFHALTEBLECH	SUPPORT	SUPPORT	1
9	A523134	SFS-TAPT.M6X12 2021 A2K	SCREW	VIS	4
10	A700545	SCHRAUBE 8X 16 933- 8.8VZ	SCREW	VIS	2
11	A348988	MUTTER SICHT- BIW M 8 A3C- 8 MITTELGESICHT	NUT	ECROU	4
12	A52147630	LUFTLEITBLECH 2-ZYLINDER VERZ	AIR GUIDE	DÉFLECTEUR	1
13	A521475	WÄRMELEITBLECH UNTEN H-4 UND 2 ZYLINDER	HEAT GARD	DÉFLECTEUR CHALEUR EN BAS	1
14	A700483	SCHRAUBE 6X 12 933- 8.8VZ	SCREW	VIS	4
15	A700798	MUTTER 6KT 6 980-V- 8	NUT	ECROU	2
16	A461894	ABWEISBLECH	PLATE	PLATEAU	1
17	A321126	MUTTER KASTEN- M 6-ST GALVZ+PASSI	NUT	ECROU	2
18	A375953	SCHRAUBE 8X 40 VERBUS RIPP	SCREW	VIS	1
19	A701765	SCHEIBE FÄCHER- A 8,4 6798 VZ	WASHER	RONDELLE	5
20	A704537	MUTTER 6KT 8 985- 8 A3B	NUT	ECROU	12
21	A700551	SCHRAUBE 8X 35 933- 8.8A3C	SCREW	VIS	3
22	A514943	PASSFEDER 1/4"X1/4"X1"A	FIT-IN KEY	GOUPILLE	1
23	A51485730	ANTRIEBSSEGMENT BBC 102 GESCHW VERZ	PULLEY	POULLIE	1
24	A521684	BBC-102 2-ZYLINDER I-5217-8F	ELECTRIC CLUTCH ASSY.	EMBRAYAGE MAGNÉTIQUE CPL	1
25	A514944	SCHRAUBE UNF 7/16"X3" 10.9	SCREW	VIS	1
26	A51494830	RIEMENFÜHRUNG FAHRANTRIEB GESCHW VERZ	BELT GUIDE	GUIDE DE COURROIRE	1
27	A704546	SCHRAUBE 8X 20 933- 8.8A3B	SCREW	VIS	3
28	A700150	SCHEIBE 8,4 9021-ST VZ	WASHER	RONDELLE	3
29	A348988	MUTTER SICHT- BIW M 8 A3C- 8 MITTELGESICHT	NUT	ECROU	1
30	A52109630	SPANNROLLENWIPPE D16 GESCHW VERZ	LEVER D16	LEVIER D16	1
31	A514717	SPANNROLLE AUSSEN+LAGER	TENSION ROLL ASSY. OUTSIDE	ROUE SERRAGE À L'EXTÉRIEUR	1
32	A514716	SPANNROLLE INNEN +LAGER	TENSION ROLL ASSY. INSIDE	ROUE SERRAGE INTÉRIEURE	1
33	A522087	ZUGFEDER-BBC	SPRING	RESSORT	1
34	A523134	SFS-TAPT.M6X12 2021 A2K	SCREW	VIS	2
35	A700148	SCHEIBE 6,4 9021-ST VZ	WASHER	RONDELLE	4



BRILL

GLORIA
Garten für Haus und Garten

14/24		RASENTRAKTOREN		Crossover	
2007		LAWN TRACTORS		102 / 20 Hydro - Art. 65059	
Rev070903		Tracteurs de pelouse		Modell 2007	
Bild Nr. REF.N° POS.N°	BEST.-NR. PART-N° N° d. PIECE	BEZEICHNUNG	DESCRIPTION	DÉSIGNATION	Qty.
36	A701171	SCHRAUBE 8X 30 933- 8.8VZ	SCREW	VIS	1
37	A70108310	SCHEIBE 8,4VZ7349"701083"	WASHER	RONDELLE	1
38	A700656	FED TEL 28 X10,2X1,25 2093	DISK SPRING	DISQUE	1
39	A51480430	DISTANZBUCHSE WIPPE VERZ	SPACER	ENTRETOISE	1
40	A514957	FÜHRUNGSBLECH 5-GANG 102	PLATE	GUIDAGE	1
41	A51421630	ZENTRIERHÜLSE VERZ.	BUSHING	DOILLE	3
42	A521391	UMLENKROLLE ALU+LAGER	PULLEY	POULIE	2
43	A704538	SCHEIBE A 8,4 125-ST A3B	WASHER	RONDELLE	3
44	A701521	SCHRAUBE 8X 40 933- 8.8VZ	SCREW	VIS	1
45	A701011	SCHRAUBE 8X 50 933- 8.8VZ	SCREW	VIS	1
46	A702477	SCHRAUBE 8X 80 931- 8.8VZ	SCREW	VIS	1
47	A514398	ÖSE-RIEMENFÜHRUNG MITTE	BELT GUIDE	GUIDAGE	1
48	A702477	SCHRAUBE 8X 80 931- 8.8VZ	SCREW	VIS	1
49	A514394	RIEMENFÜHRUNG VERZ	BELT GUIDE	GUIDAGE COURROIE	1
50	A521391	UMLENKROLLE ALU+LAGER	PULLEY ASSY	POULIE GUIDAGE CPL	1
51	A46149301	RIEMENFÜHRUNG HD102 GESCHW R9005	BELT GUIDE	GUIDAGE COURROIE	1
52	A700573	SCHRAUBE 6X 20 603- 4.6VZ	SCREW	VIS	2
53	A704536	MUTTER 6KT 6 985- 8 A3B	NUT	ECROU	2



BRILL

GLORIA
Geräte für Haus und Garten

15/24 RASENTRAKTOREN
 2007 LAWN TRACTORS
 Rev070903 Tracteurs de pelouse

Crossover

102 / 20 Hydro - Art. 65059
 Modell 2007



Crossover
 102 / 20 HE Hydro

Art. 65059
 2007

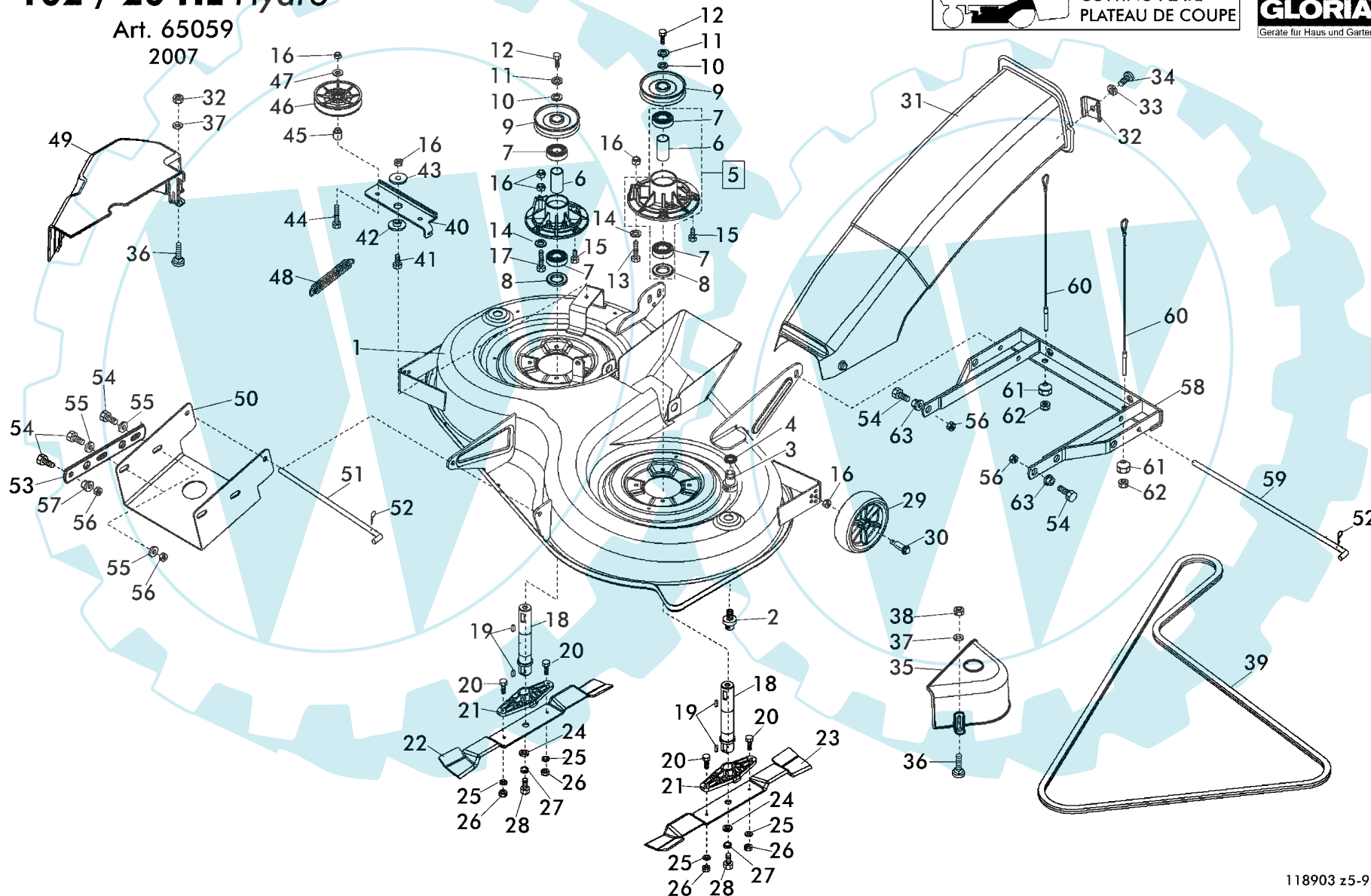

118903 z5-9

16/24		Crossover		SCHNEIDWERK CUTTING PLATE PLATEAU DE COUPE		BRILL GLORIA Garten für Haus und Garten	
2007		LAWN TRACTORS		102 / 20 Hydro - Art. 65059			
Rev070903		Tracteurs de pelouse		Modell 2007			
Bild Nr. REF.N° POS.N°	BEST.-NR. PART-N° N° d. PIECE	BEZEICHNUNG	DESCRIPTION	DÉSIGNATION	Qty.		
1	A51482601	SCHNEIDGEHÄUSE 102 GESCHW R9005	CUTTING CHASSIS 102	PLATEAU DE COUPE	1		
2	A321182	SPÜLDÜSE R1/2"	WATER HOSE CONNECTION	RACCORD TUYAU D'EAU	2		
3	A321347	ANSCHLUSS R1/2"	TUBE ADAPTER	ADAPTER TUYAU	2		
4	A522575	O-RING D10,78X2,62 NBR	O-RING	O-RING	2		
5	A514258	LAGERBOCK KPL.	BLADE FLANGE ASSY. CPL	ENS. BRIDE POUR LAME CPL	2		
6	A514094	DISTANZBUCHSE-1	SPACER	ENTRETOISE	2		
7	A700503	KUGELLAGER 6205 2RS 625	BALL BEARING	ROULEMENT À BILLES	4		
8	A704863	RWDR AS 30X 52X 5 3760-NB	WASHER	RONDELLE	2		
9	A521451	RIEMENSCHLEIBE VERSCHRAUBT 102 KPL	PULLEY ASSY	POULIE	2		
10	A515246	SCHEIBE 30/10,5 X 5	WASHER	RONDELLE	2		
11	A705284	TELLERFEDER 28 X10,2X1,5 2093	DISK SPRING	RESSORT D'ASSIETTE	2		
12	A704054	SCHRAUBE 10X1,0 X 35 961- 8.8	SCREW	VIS	2		
13	A701011	SCHRAUBE 8X 50 933- 8.8VZ	SCREW	VIS	1		
14	A701765	SCHEIBE FÄCHER- A 8,4 6798 VZ	WASHER	RONDELLE	2		
15	A521281	SCHRAUBE-TAPT 8X25 SPERRZ.A3S	SCREW	VIS	6		
16	A704537	MUTTER 6KT 8 985- 8 A3B	NUT	ECROU	6		
17	A701704	SCHRAUBE 8X 60 933- 8.8VZ	SCREW	VIS	1		
18	A461785	MESSERWELLE TRAKTOR VERZ	BLADE SHAFT	ABRE	2		
19	A701595	PASSFEDER 8X7X20 6885	FIT-IN KEY	GOUPILLE	4		
20	A700702	SCHRAUBE 6X 25 933- 8.8VZ	SCREW	VIS	4		
21	A514176	MESSERHALTER	BLADE FLANGE	BRIDE	2		
22	A521207	FLÜGELMESSER RECHTS TR-102	WING BLADE RIGHT 102	LAME DROITE 102	1		
23	A521208	FLÜGELMESSER LINKS TR-102	WING BLADE LEFT 102	LAME GAUCHE 102	1		
24	A515246	SCHEIBE 30/10,5 X 5	WASHER	RONDELLE	2		
25	A700137	SCHEIBE A 6,4 125-ST VZ	WASHER	RONDELLE	4		
26	A704536	MUTTER 6KT 6 985- 8 A3B	NUT	ECROU	4		
27	A702254	SCHEIBE FÄCHER- A 10,5 6798 VZ	WASHER	RONDELLE	2		
28	A704054	SCHRAUBE 10X1,0 X 35 961- 8.8	SCREW	VIS	2		
29	A514887	RAD 125 R9005	WHEEL 125 CPL	ROUE CPL 125	2		
30	A52111030	RADBOLZEN 102 VERZ	WHEEL BOLT	BOULLON ROUE	2		
31	A514851	AUSWURFKANAL TRAKTOR 102	FUNNEL ASSY	BUSE EJECTER CPL	1		
32	A521201	FIXIERUNGSSCHEIBE 102	FIXING PLATE	PLATEAU FIXATION	2		
33	A700200	SCHEIBE FÄCHER- J 6,4 6798 VZ	WASHER	RONDELLE	2		
34	A700702	SCHRAUBE 6X 25 933- 8.8VZ	SCREW	VIS	2		
35	A51489701	ABDECKUNG MÄHANTRIEB LINKS R9005	BELT COVER LEFT	BARRIÈRE GAUCHE CPL	1		

17/24		RASENTRAKTOREN		Crossover	
2007		LAWN TRACTORS		102 / 20 Hydro - Art. 65059	
Rev070903		Tracteurs de pelouse		Modell 2007	
Bild Nr. REF.N° POS.N°	BEST.-NR. PART-N° N° d. PIECE	BEZEICHNUNG	DESCRIPTION	DÉSIGNATION	Qty.
36	A703484	SCHRAUBE 5X 16 603- 4.6A3C	SCREW	VIS	5
37	A700147	SCHEIBE 5,3 9021-ST VZ	WASHER	RONDELLE	5
38	A700119	MUTTER 6KT 5 985- 8 VZ	NUT	ECROU	5
39	A514877	MÄHANTRIEBSRIEMEN 102	V-BELT 102	COURROIE 102	1
40	A51486830	SPANNWIPPE BBC VZKT	SUPPORT	SUPPORT	1
41	A701171	SCHRAUBE 8X 30 933- 8.8VZ	SCREW	VIS	1
42	A51422030	DISTANZSCHEIBE VERZ	SPACER	ENTRETOISE	1
43	A51422030	DISTANZSCHEIBE VERZ	SPACER	ENTRETOISE	1
44	A701521	SCHRAUBE 8X 40 933- 8.8VZ	SCREW	VIS	1
45	A51421630	ZENTRIERHÜLSE VERZ.	BUSHING	DOILLE	1
46	A514716	SPANNROLLE INNEN + LAGER	TENSIONER INSIDE ASSY	ROUE SERRAGE	1
47	A701138	SCHRAUBE ST4,2X13 -C-H7981 VZ	SCREW	VIS	1
48	A522087	ZUGFEDER-BBC	SPRING	RESSORT	1
49	A51487501	ABDECKUNG MÄHANTRIEB RECHTS R9005	BELT COVER RIGHT R9005	BARRIÈRE DROITE CPL	1
50	A46113601	MÄHDECKAUFHÄNGUNG VORNE R9005	CUTTING PLATE SUPPORT FRONT	PLATEAU SUSPENSION L'AVANT	1
51	A51425330	ABSTECKSTANGE VERZ.	ROD	BARRE	1
52	A701626	FEDERSTECKER - 2,5 11024 VZ	COTTER PIN	GOUPILLE	2
53	A51421301	SCHENKEL-VORNE HÖHENVERSTELLUNG R9005	SUPPORT	SUPPORT	2
54	A700704	SCHRAUBE 10X 30 933- 8.8VZ	SCREW	VIS	8
55	A700151	SCHEIBE 10,5 9021-ST VZ	WASHER	RONDELLE	8
56	A703813	MUTTER 6KT 10 985-10 A3B	NUT	ECROU	8
57	A51415930	DISTANZSCHEIBE VERZ	SPACER	ENTRETOISE	2
58	A51483401	AUFHÄNGUNG HINTEN 102 GESCHW R9005	REAR FRAME	SUSPENSION ARRIÈRE 102	1
59	A51486630	ABSTECKSTANGE HINTEN VERZ	ROD	BARRE	1
60	A514861	DRAHTSEIL	STEEL WIRE ROPE	CABLE D'ACIER	2
61	A2088890005	KUGELMUTTER M8	NUT	ECROU	2
62	A704533	MUTTER 8 934- 8 A3B	NUT	ECROU	2
63	A51415930	DISTANZSCHEIBE VERZ	SPACER	ENTRETOISE	2



18/24	RASENTRAKTOREN
2007	LAWN TRACTORS
Rev070903	Tracteurs de pelouse

Crossover

102 / 20 Hydro - Art. 65059
Modell 2007

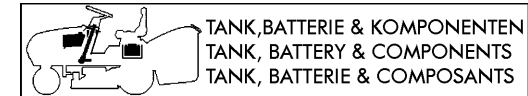

Crossover

102 / 20 HE Hydro

Art. 65059
2007

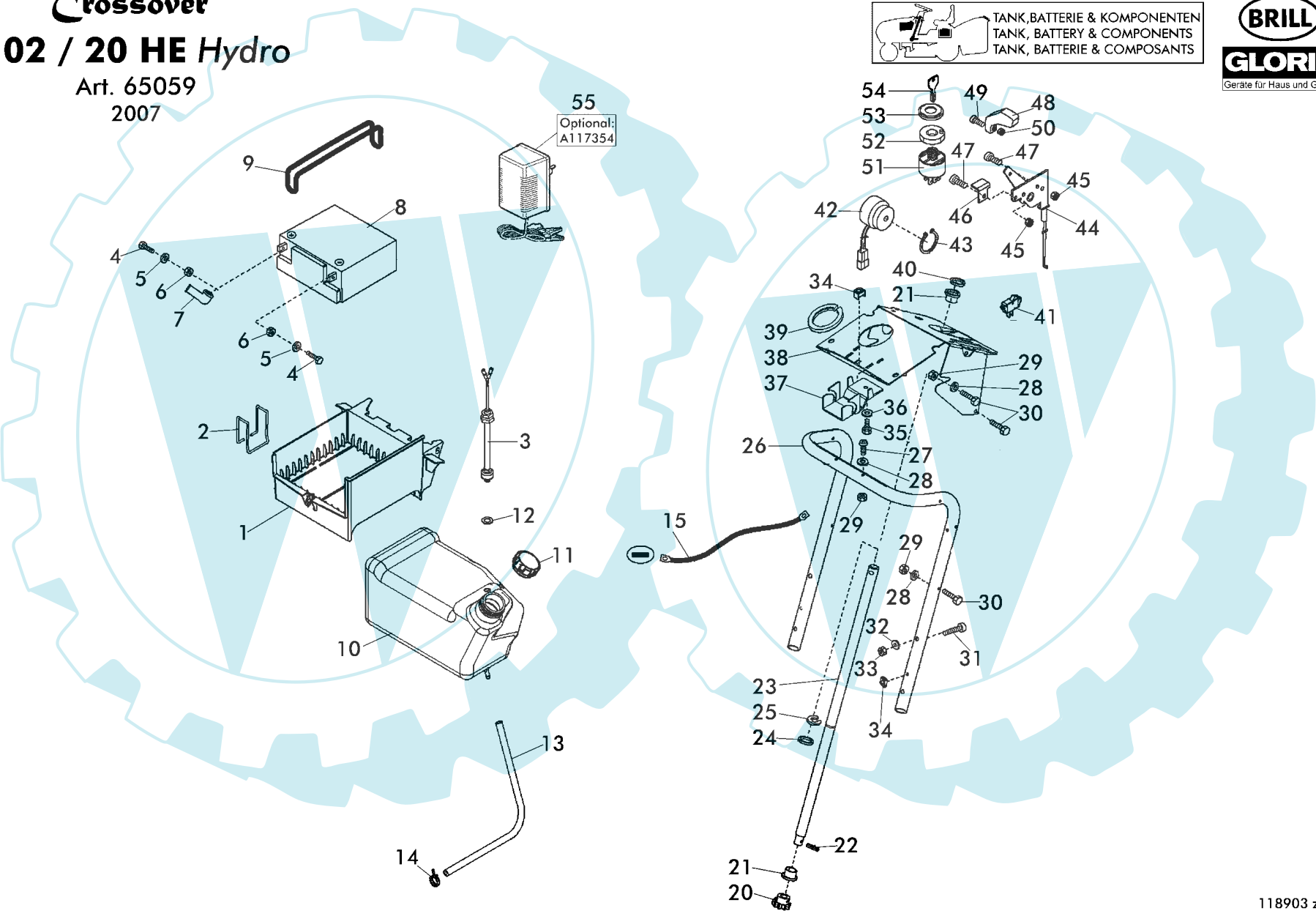
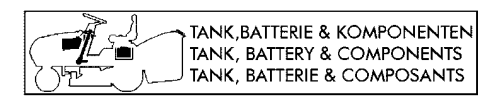

118903 z6-9

19/24		RASENTRAKTOREN		Crossover	
2007		LAWN TRACTORS		102 / 20 Hydro - Art. 65059	
Rev070903		Tracteurs de pelouse		Modell 2007	
Bild Nr. REF.N° POS.N°	BEST.-NR. PART-N° N° d. PIECE	BEZEICHNUNG	DESCRIPTION	DÉSIGNATION	Qty.
1	A514670	BATTERIEKASTEN	BATTERY INSERT	BATTERIE CAISSE	1
2	A521847	FEDERBÜGEL TRAKTOR	BRACKET	SUPPORT	1
3	A521626	SCHWIMMERSCHALTER	SWITCH	INTERRUPTEUR	1
4	A700974	SCHRAUBE 5X 16 933- 8.8VZ	SCREW	VIS	4
5	A701365	SCHEIBE FÄCHER- A 5,3 6798 VZ	WASHER	RONDELLE	4
6	A700106	MUTTER 5 934- 8 VZ	NUT	ECROU	4
7	A451001	BATTERIEPOLABDECKUNG FÜR BATTERIE CSB	POL COVER	COUVERCLE DE PROTECTION	1
8	BA042037	BATTERIE 12V-17Ah	BATTERY 12 V-17Ah	BATTERIE 12V-17Ah	1
9	A514818	BEFESTIGUNGSGUMMI	RUBBER BAND	ÉLASTIQUE	1
10	A521818	BENZINTANK 102 2-ZY NA	TANK 102	TANK 102	1
11	A544600	TANKDECKEL KPL	TANK CAP	BOUCHON DE RÉSERVOIR	1
12	A521735	DICHTUNG	SEAL	JOINT	1
13	A521769	BENZINSCHLAUCH ZUSCHNITT 450MM	TUBE 450 MM	TUYAU	1
14	A544515	SCHLAUCHKLEMME 14,5	TUBE CLAMP	BORNE	2
15	A514889	ZUSATZ MASSEKABEL	GROUND CABLE	CABLE	1
20	A51400930	LENKUNGSRIESEL VERZ.	STEERING WHEEL	PIGNON	1
21	A514197	EP-BUNDBUCHSE	BUSH	DOILLE	2
22	A704275	SPANNSTIFT 6X24 7344	PIN	GOUPILLE	1
23	A514032	LENKSÄULE VERZ	STEERING COLUMN	TUBE DE DIRECTION	1
24	A700719	SCHEIBE 21 433 VZ	WASHER	RONDELLE	1
25	A702724	SCHEIBE SICHERHEIT 15 6799 VZ	WASHER	RONDELLE	1
26	A514049	STÜTZHOLM	SUPPORT	SUPPORT	1
27	A701489	SCHRAUBE 6X 35 933- 8.8VZ	SCREW	VIS	2
28	A700148	SCHEIBE 6,4 9021-ST VZ	WASHER	RONDELLE	6
29	A701536	SPANNHUELSE 8 X 40 1481	BUSH CLAMP	DOILLE TENDRE	8
30	A700553	SCHRAUBE 6X 40 933- 8.8VZ	SCREW	VIS	6
31	A703191	SCHRAUBE 8X 40 7991- 8.8A3C	SCREW	VIS	4
32	A701765	SCHEIBE FÄCHER- A 8,4 6798 VZ	WASHER	RONDELLE	4
33	A704537	MUTTER 6KT 8 985- 8 A3B	NUT	ECROU	4
34	A321126	MUTTER KASTEN- M 6-ST GALVZ+PASSI	NUT	ECROU	4
35	A700555	SCHRAUBE 6X 16 933- 8.8VZ	SCREW	VIS	1
36	A700200	SCHEIBE FÄCHER- J 6,4 6798 VZ	WASHER	RONDELLE	1
37	A514416	EINRASTBLECH	ENGAGE PLATE	PANNEAU ENCLIQUETER	1
38	A514085	STÜTZBLECH	SUPPORT	SUPPORT	1
39	A521771	KANTENSCHUTZ 120 MM	BORDER GUARD 120 MM	LISIÈRE PROTECTEUR 120MM	1

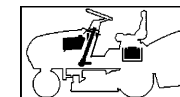

TANK, BATTERIE & KOMPONENTEN
TANK, BATTERY & COMPONENTS
TANK, BATTERIE & COMPOSANTS



20/24		RASENTRAKTOREN		Crossover	
2007		LAWN TRACTORS		102 / 20 Hydro - Art. 65059	
Rev070903		Tracteurs de pelouse		Modell 2007	
Bild Nr. REF.N° POS.N°		BEST.-NR. PART-N° N° d. PIECE		BEZEICHNUNG	
				DESCRIPTION	
				DÉSIGNATION	
				Qty.	
40	A521115	SCHNELLBEFESTIGER20SXN26	CROWN FASTENER	FIXATEUR A COURONNE	1
41	A514328	KIPPSCHALTER LICHT	ROCKER SWITCH I/O	INERRUPTEUR À BASCULE	1
42	A514319	FÜLLSTANDSUMMER	BUZZER (GRASS BAG FULL)	BUZZER	1
43	A701296	SICHERUNGSRING 25X1,2 471	CIRCLIP	CIRCLIPS	1
44	A521729	GASFERNBEDIENUNG 2-ZYLINDER	THROTTLE CABLE	CABLE	1
45	A700119	MÜTTER 6KT 5 985- 8 VZ	NUT	ECROU	2
46	A52174130	ANSCHLAGWINKEL"FERNBEDIENUNG"VERZ	BLOCK	BUTOIR	1
47	A702830	SCHRAUBE 5X 12 7985- 4.8-H A3R	SCREW	VIS	2
48	A514395	BEDIENHEBEL	LEVER	LEVIER	1
49	A700961	SCHRAUBE 4X 8 7985- 4.8-H VZ	SCREW	VIS	1
50	A701352	MÜTTER 6KT 4 985- 8 VZ	NUT	ECROU	1
51	A525315	ZÜNDANLASSSCHALTER RIDER	IGNITION SWITCH	INTERRUPTEUR DEMARR. /1	1
52	A514336	VERDREHSICHERUNG ZÜNDSCHLOSS	SAFETY NUT	EMBOUT	1
53	A514335	BEFESTIGUNGS MÜTTER ZÜNDSCHLOSS	LOCK NUT	EMBOUT	1
54	A525316	ZÜNDSCHLÜSSEL	STARTING KEY	CLEF A DEMARRAGE	2
55	A117354	LADEGERÄT Crossover 12 V (optional)	CHARGER Crossover 12 V (optional)	CHARGEUR Crossover 12 V (optional)	1

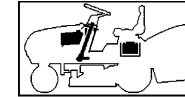

TANK, BATTERIE & KOMPONENTEN
TANK, BATTERY & COMPONENTS
TANK, BATTERIE & COMPOSANTS



21/21	RASENTRAKTOREN
2007	LAWN TRACTORS
Rev070903	Tracteurs de pelouse

Crossover
102 / 20 Hydro - Art. 65059
 Modell 2007

GRASFANGSACK KPL.
 GRASS CATCHER ASSY.
 BAC COMPOSANTS



Crossover
102 / 20 HE Hydro
 Art. 65059
 2007

GRASFANGSACK KPL.
 GRASS CATCHER ASSY.
 BAC COMPOSANTS

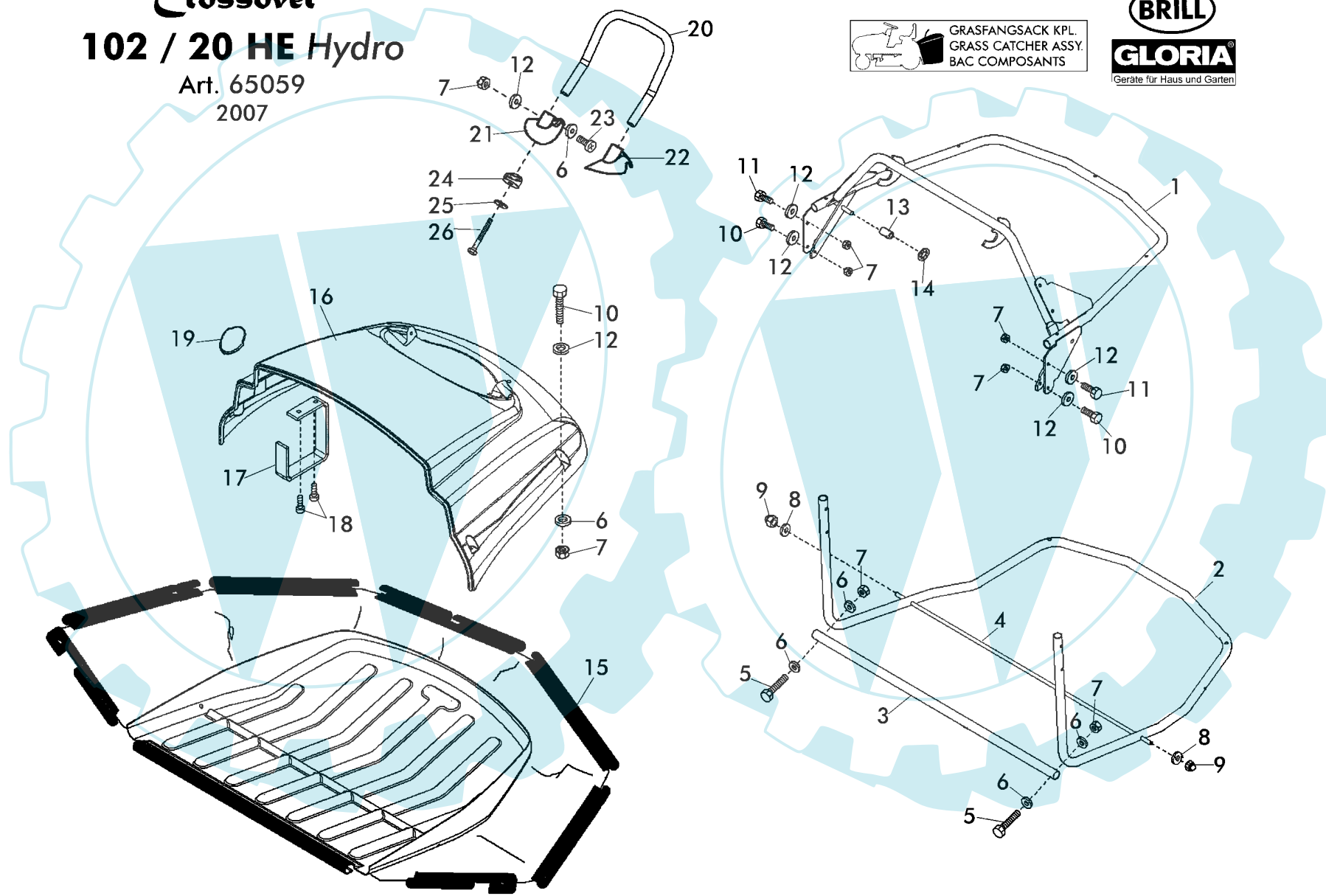

118903 z1-9

22/24		RASENTRAKTOREN		Crossover	
2007		LAWN TRACTORS		102 / 20 Hydro - Art. 65059	
Rev070903		Tracteurs de pelouse		Modell 2007	
Bild Nr. REF.N° POS.N°	BEST.-NR. PART-N° N° d. PIECE	BEZEICHNUNG	DESCRIPTION	DÉSIGNATION	Qty.
1	A52172201	BOXROHR GESCHW 102 E-BOX R9005	UPPER FRAME ASSY	CHASSIS SUPERIEUR	1
2	A514884	BOXROHR UNTEN 102	LOWER FRAME ASSY	CHASSIS INFERIEUR	1
3	A514183	QUERSTREBE BOX	ROD	TIGE	1
4	A52175030	BOXSTREBE TRAKTOR 102/E-BOX VERZ	SUPPORT ROD	RENFORCEMENT	1
5	A703563	SCHRAUBE 6X 45 933- 8.8A3C	SCREW	VIS	2
6	A700137	SCHEIBE A 6,4 125-ST VZ	WASHER	RONDELLE	11
7	A704536	MUTTER 6KT 6 985- 8 A3B	NUT	ECROU	13
8	A704538	SCHEIBE A 8,4 125-ST A3B	WASHER	RONDELLE	2
9	A701124	MUTTER HUT 8 986- 8 VZ	NUT	ECROU	2
10	A704325	SCHRAUBE 6X 40 933- 8.8A3S	SCREW	VIS	7
11	A702880	SCHRAUBE 6X 30 933- 8.8A3S	SCREW	VIS	2
12	A703005	SCHEIBE 6,4 9021-ST A3S	WASHER	RONDELLE	11
13	A52161930	DISTANZBUCHSE VERZ	SPACER	ENTRETOISE	2
14	A510566	SCHNELLBEFESTIGER 8SXN26	CROWN FASTENER	FIXATEUR A COURONNE	2
15	A514883	GEWEBESACK 102 KPL	GRAS CATCHER BAG ASSY 102	BAC	1
16	A52157947	BOXDECKEL TR 2X BOHREN	BAG COVER	COUVRE-BAC VERT	1
17	A52163030	BOXABFRAGE E-BOX UND DISPLAY VERZ	BRACKET	SUPPORT	1
18	A348954	SCHRAUBE.PT-KB 60X25 1411 VZ	SCREW	VIS	2
19	A52104101	VERSCHLUSSTOPFEN R9005	CAP	BOUCHON	1
20	A521172	BOXGRIFF + ROHREINS.M8 KP	HANDLE	POINGEE	1
21	A52105701	AUFSATZ RECHTS R9005	ADAPTER RIGHT	ADAPTER DROITE	1
22	A52105601	AUFSATZ LINKS R9005	ADAPTER LEFT	ADAPTER GAUCHE	1
23	A700496	SCHRAUBE 6X 20 912- 8.8	SCREW	VIS	2
24	A521471	UNTERLAGSCHEIBE FÜR GRIFF	WASHER	RONDELLE	2
25	A700150	SCHEIBE 8,4 9021-ST VZ	WASHER	RONDELLE	2
26	A701704	SCHRAUBE 8X 60 933- 8.8VZ	SCREW	VIS	2



GRASFANGSACK KPL.
GRASS CATCHER ASSY.
BAC COMPOSANTS



23/24 RASENTRAKTOREN
 2007 LAWN TRACTORS
 Rev070903 Tracteurs de pelouse

Crossover
102 / 20 Hydro - Art. 65059
 Modell 2007



Bild Nr. REF.N° POS.N°	BEST.-NR. PART-N° N° d. PIECE	BEZEICHUNG	DESCRIPTION	DÉSIGNATION	Qty.
1	A521624	KABELBAUM 102 "2-ZYLINDER"	CABLE ASSY 102 -2 CYL	CABLE ELECTRIQUE CPL	1
2	A521849	RELAIS BOSCH-NR.0332209137	RELAIS	RELAIS	1
3	A521820	STECKSICHERUNG 5 A	FUSE 5A	FUSIBLE 5A	1
4	A521821	STECKSICHERUNG 10 A	FUSE10A	FUSIBLE 10A	1
5	A521819	STECKSICHERUNG 15 A	FUSE 15A	FUSIBLE 15A	1
6	A521363	KABEL ROT STARTER/RELAIS	CABLE RED (RELAIS)	CABLE ROUGE (RELAIS)	1
7	A521365	KABEL BLAU MASSELEITER	CABLE BLUE (GROUND CABLE)	CABLE BLEU	1
8	A521366	KABEL ROT BATTERIE/RELAIS	CABLE RED BATTERY * RELAIS	CABLE ROUGE (BATTERIE-RELAIS)	1

24/24 RASENTRAKTOREN
 2007 LAWN TRACTORS
 Rev070903 Tracteurs de pelouse

Crossover
102 / 20 Hydro - Art. 65059
 Modell 2007

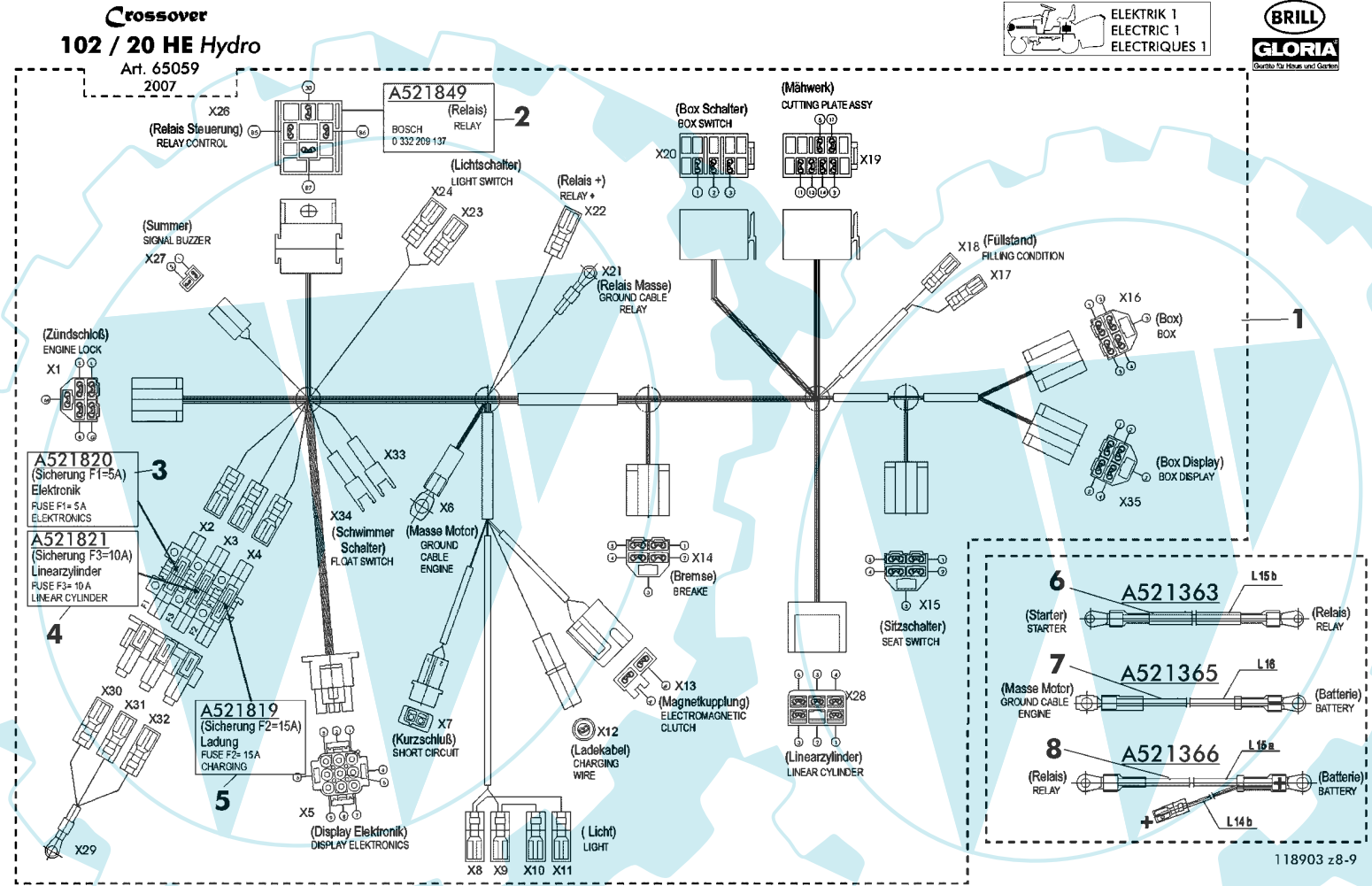
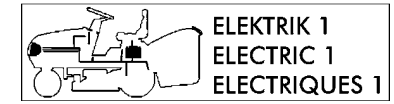
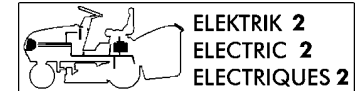

Crossover
102 / 20 HE Hydro
 Art. 65059
 2007

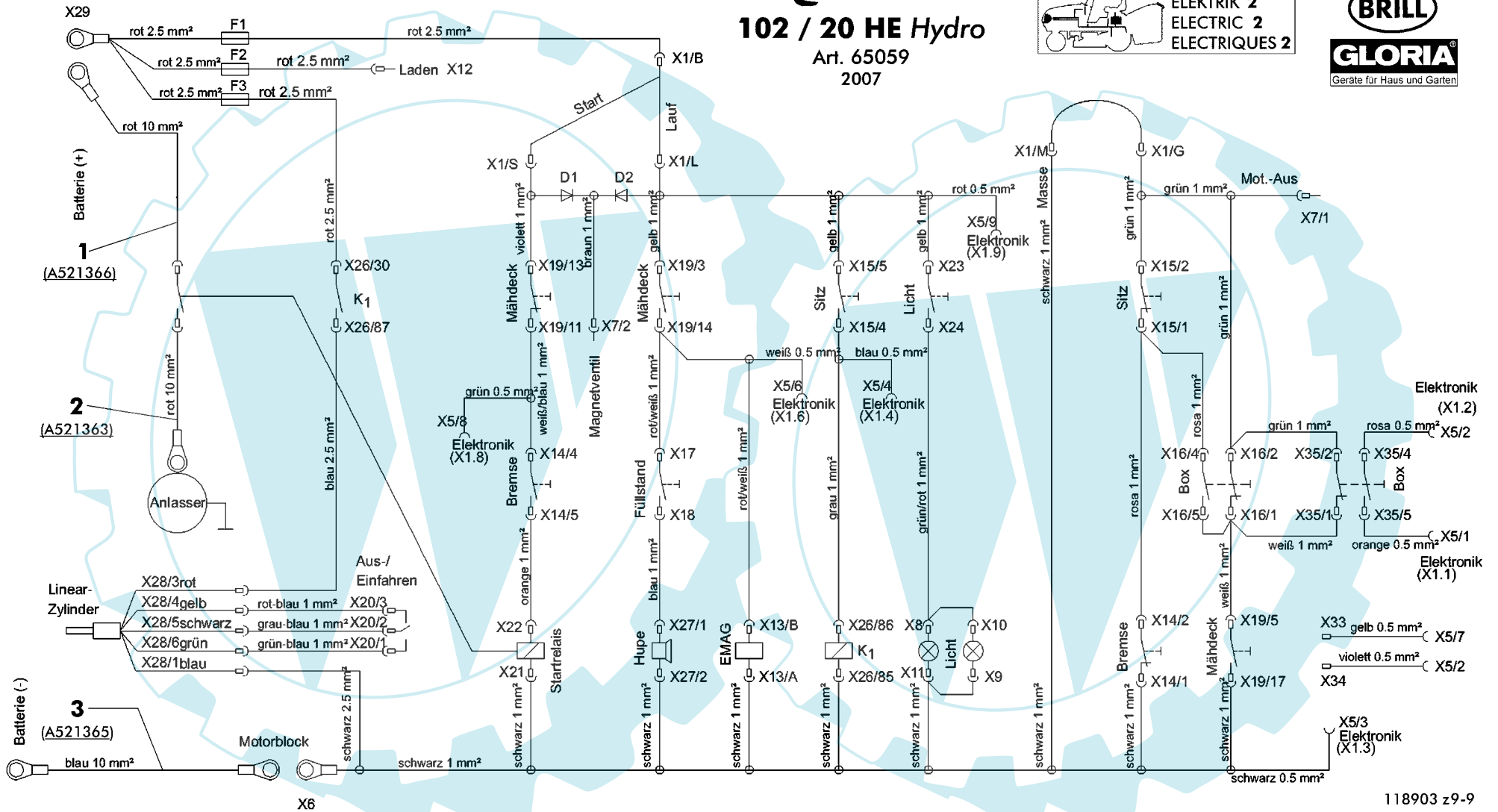
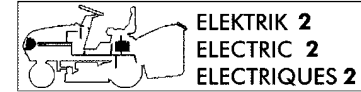

118903 z9-9

Bild Nr. REF.N° POS.N°	BEST.-NR. PART-N° N° d. PIECE	BEZEICHNUNG	DESCRIPTION	DÉSIGNATION	Qty.
1	A521366	KABEL ROT BATTERIE/RELAIS	CABLE RED BATTERY * RELAIS	CABLE ROUGE (BATTERIE-RALAIS)	1
2	A521363	KABEL ROT STARTER/RELAIS	CABLE RED (RELAIS)	CABLE ROUGE (RELAIS)	1
3	A521365	KABEL BLAU MASSELEITER	CABLE BLUE (GROUNDING CABLE)	CABLE BLEU	1